

# CALIPER

BORN IN ITALY, RAISED BY THE WORLD

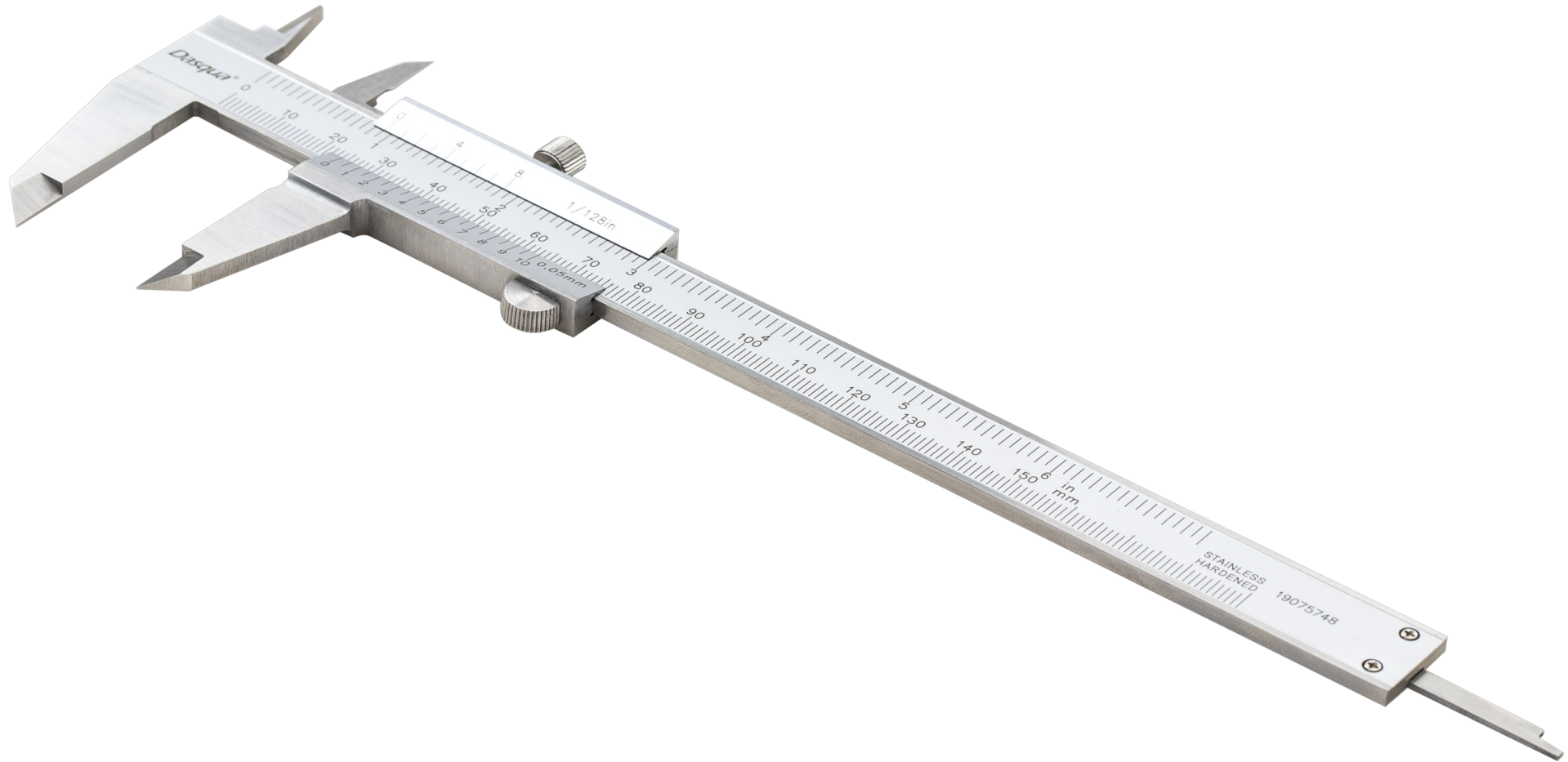

1380-3005	0-150mm MONOBLOK MEKANİK KUMPAS 0,02 DIN862	39,00 USD
1380-3010	0-200mm MONOBLOK MEKANİK KUMPAS 0,02 DIN862	61,50 USD
1380-3015	0-300mm MONOBLOK MEKANİK KUMPAS 0,02 DIN862	116,50 USD
1120-3113	0-70mm MONOBLOK MEKANİK KUMPAS 0,05 DIN862	32,00 USD
1120-3114	0-100mm MONOBLOK MEKANİK KUMPAS 0,05 DIN862	30,00 USD
1120-3115	0-150mm MONOBLOK MEKANİK KUMPAS 0,05 DIN862	34,00 USD
1120-3120	0-200mm MONOBLOK MEKANİK KUMPAS 0,05 DIN862	56,00 USD
1120-3130	0-300mm MONOBLOK MEKANİK KUMPAS 0,05 DIN862	111,00 USD
1801-0505	0-150mm KENARI TİN KAPLAMALI MEKANİK KUMPAS 0,05	34,00 USD

# Solid Stainless Steel Made

- Strictly made in accordance with DIN862
- Supplied in fitted solid ABS case with special branded plastic bag and warranty letter in it



1310-0005	0-500mm TEK ÇENE MEKANİK KUMPAS 0,02 ÇENE BOYU:100	266,00 USD
1310-0006	0-500mm TEK ÇENE MEKANİK KUMPAS 0,02 ÇENE BOYU:150	380,00 USD
1310-0010	0-600mm TEK ÇENE MEKANİK KUMPAS 0,02 ÇENE BOYU:100	290,00 USD
1310-0011	0-600mm TEK ÇENE MEKANİK KUMPAS 0,02 ÇENE BOYU:150	420,00 USD
1310-0015	0-1000mm TEK ÇENE MEKANİK KUMPAS 0,02 ÇENE BOYU:125	832,00 USD
1310-0016	0-1000mm TEK ÇENE MEKANİK KUMPAS 0,02 ÇENE BOYU:200	975,00 USD
1310-0020	0-1500mm TEK ÇENE MEKANİK KUMPAS 0,02 ÇENE BOYU:150	1575,00 USD

1300-5005	0-300mm ÇİFT ÇENE MEKANİK KUMPAS -90mm ÇENE 0,02	278,00 USD
1300-5010	0-500mm ÇİFT ÇENE MEKANİK KUMPAS -100mm ÇENE 0,02	500,00 USD
1300-5015	0-500mm ÇİFT ÇENE MEKANİK KUMPAS -150mm ÇENE 0,02	548,00 USD
1300-5020	0-600mm ÇİFT ÇENE MEKANİK KUMPAS -100mm ÇENE 0,02	613,00 USD
1300-5025	0-800mm ÇİFT ÇENE MEKANİK KUMPAS -150mm ÇENE 0,02	1012,00 USD
1300-5030	0-1000mm ÇİFT ÇENE MEKANİK KUMPAS -150mm ÇENE 0,02	1160,00 USD

# DIAL CALIPER

DOUBLE SHOCK-PROOF

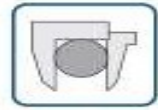

01

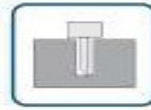

02

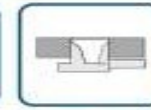

03

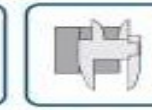





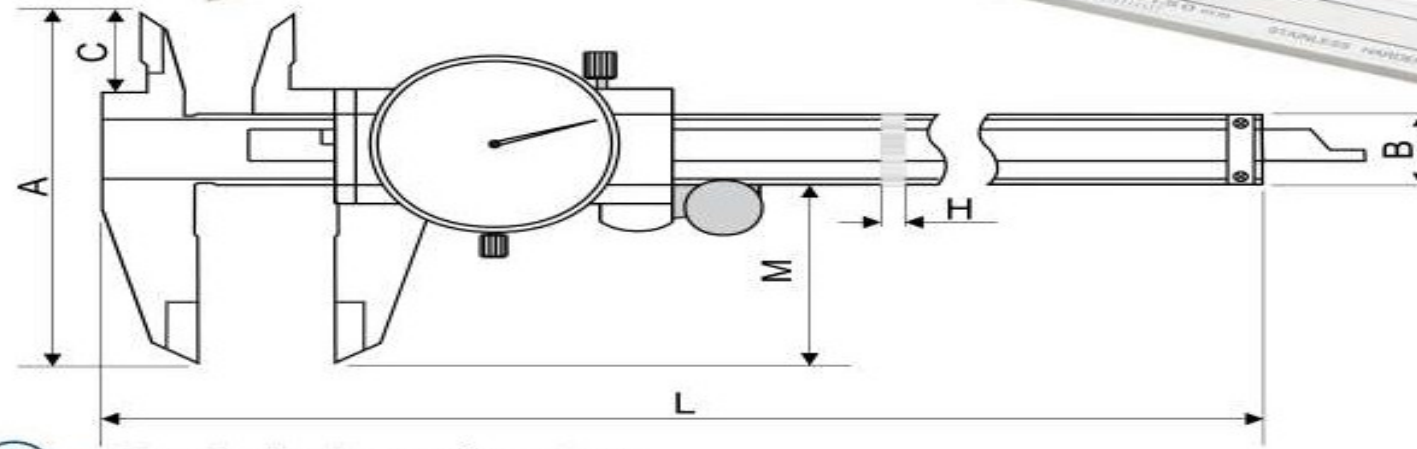
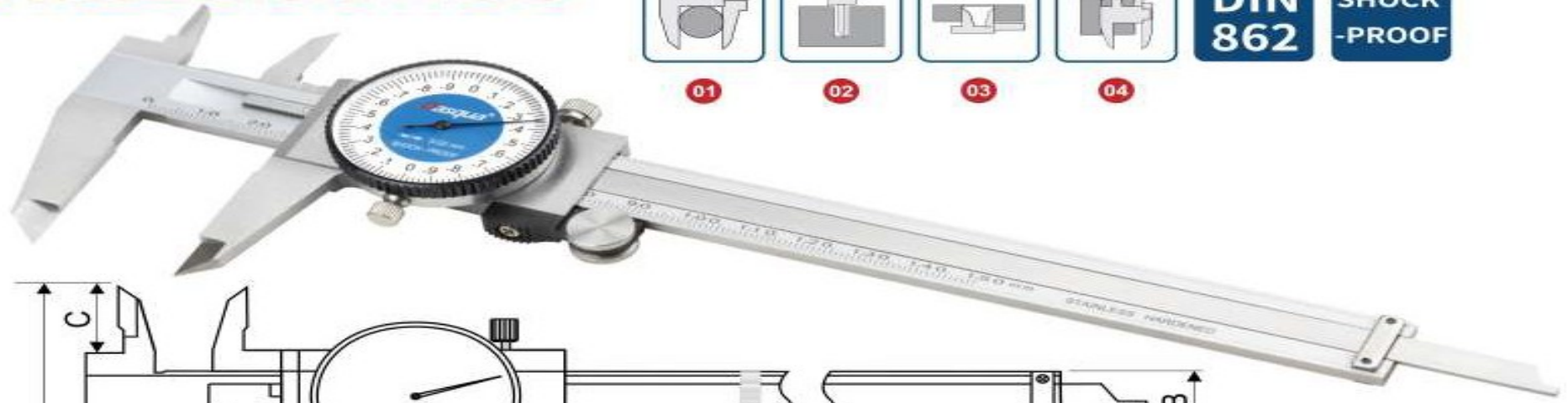

04

DIN 862

SHOCK-PROOF



-  Tough shock-proof gearing
-  4 usages for measuring outside diameter, inside diameter step and depth
-  Made of solid stainless steel
-  Strictly made in accordance with DIN862
-  Distinct lines and figures laser etched against satin chrome finish
-  With locking screw for stable reading

1331-2115	0-150mm SAATLI KUMPAS -SHOCK PROOF 0,02	71,00 USD
1350-5005	0-150mm SAATLI KUMPAS -SHOCK PROOF 0,01	79,50 USD
1350-5010	0-200mm SAATLI KUMPAS -SHOCK PROOF 0,01	115,00 USD
1350-5015	0-300mm SAATLI KUMPAS -SHOCK PROOF 0,01	178,00 USD



2050-0005 0-100mm MİNİ DİJİTAL KUMPAS 0,01mm/0,0005"

60,50 USD

2035-0005 0-150mm DİJİTAL PLASTİK KUMPAS 0,01mm/0,0005"

24,00 USD

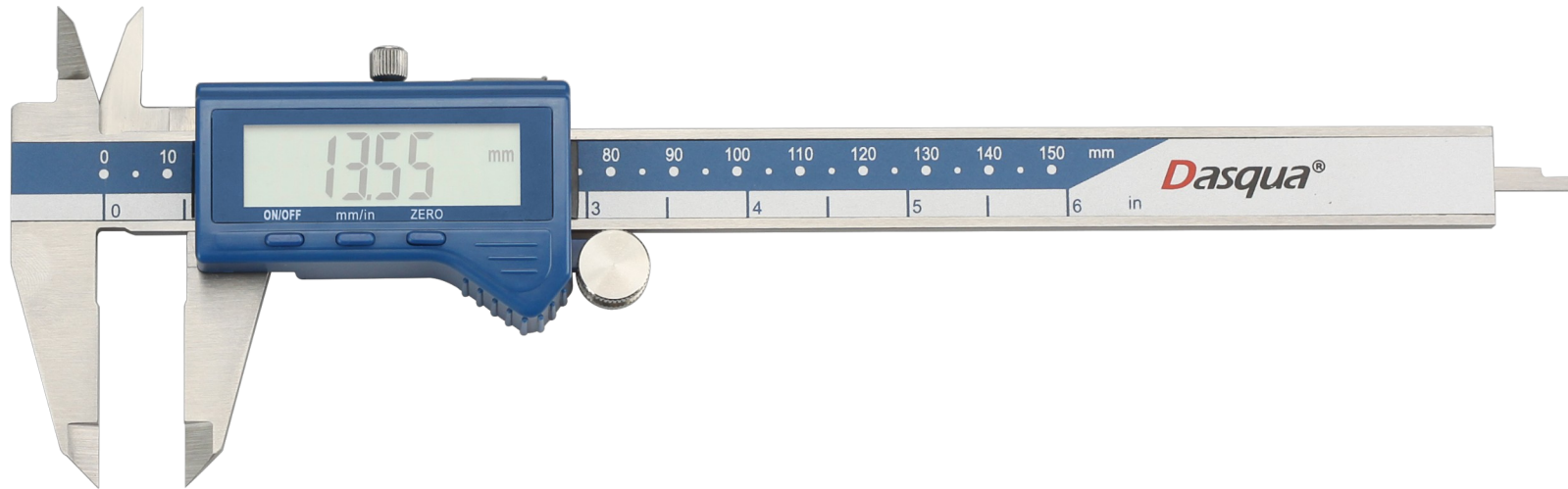

1804-1065 0-150mm "EKONOMİK SERİ" DİJİTAL KUMPAS 0,01mm/0,005"

48,00 USD

1804-1070 0-200mm "EKONOMİK SERİ" DİJİTAL KUMPAS 0,01mm/0,005"

79,50 USD

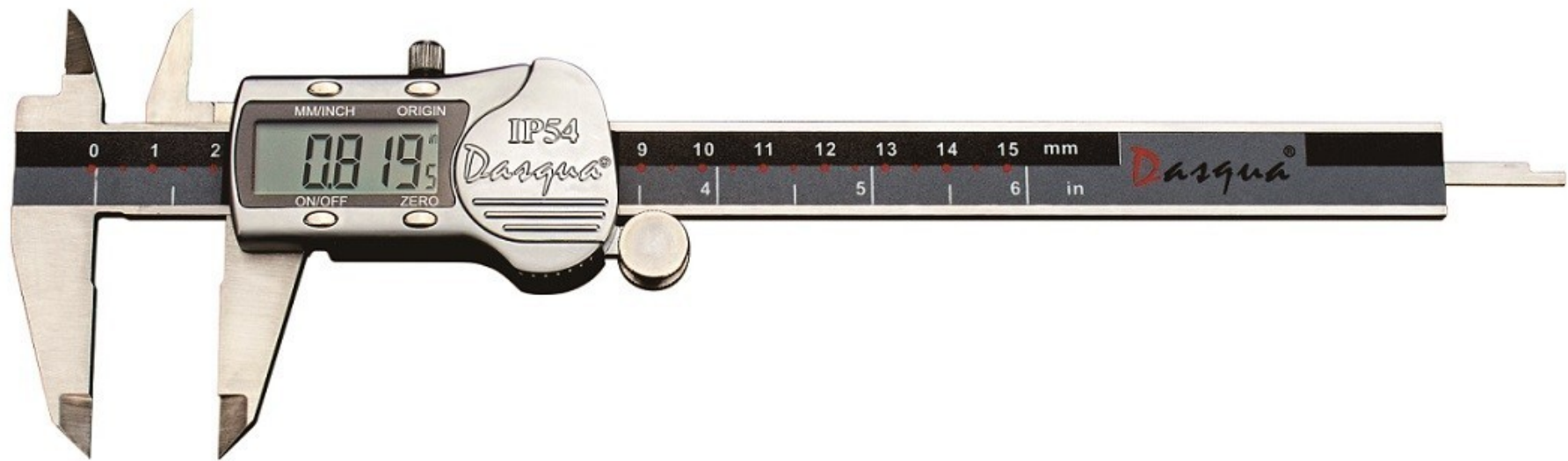

**2117-9105 0-150mm METAL KASA DIJITAL KUMPAS IP54**

**71,00 USD**

**2117-9110 0-200mm METAL KASA DIJITAL KUMPAS IP54**

**89,00 USD**

**2117-9115 0-300mm METAL KASA DIJITAL KUMPAS IP54**

**128,50 USD**



**2115-2305 0-150mm ABSOLUTE METAL KASA DIJITAL KUMPAS IP54**

**77,00 USD**

**2115-2310 0-200mm ABSOLUTE METAL KASA DIJITAL KUMPAS IP54**

**95,00 USD**

**2115-2315 0-300mm ABSOLUTE METAL KASA DIJITAL KUMPAS IP54**

**135,50 USD**

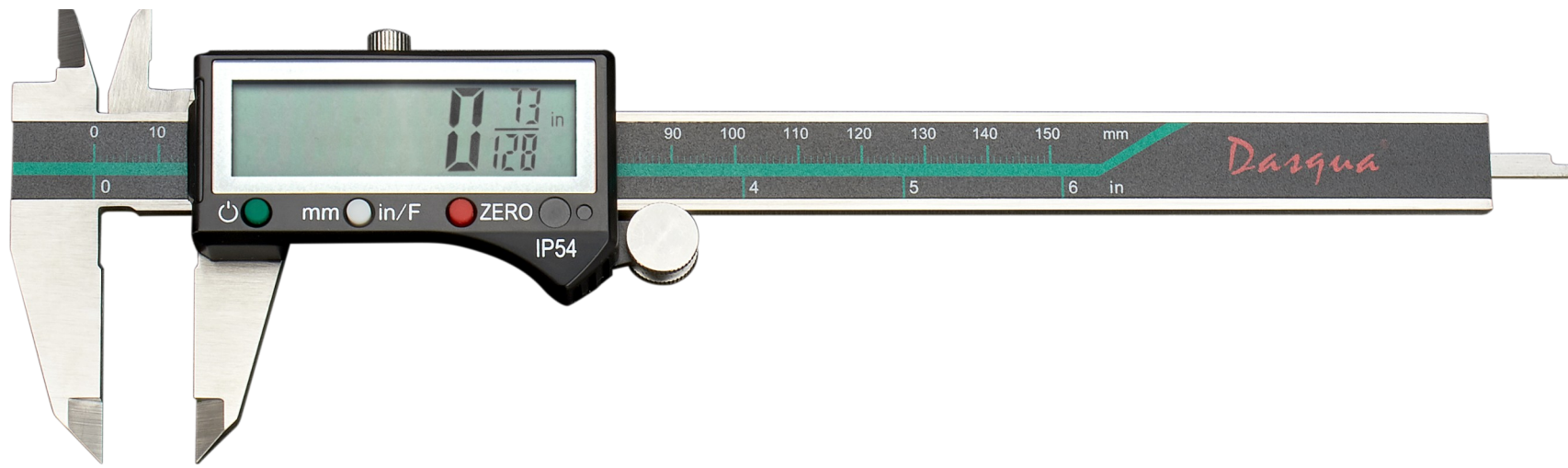

2310-7105 0-150mm LCD BÜYÜK EKTRAN DİJİTAL KUMPAS IP54

71,00 USD

2310-7110 0-200mm LCD BÜYÜK EKTRAN DİJİTAL KUMPAS IP54

89,00 USD

2310-7115 0-300mm LCD BÜYÜK EKTRAN DİJİTAL KUMPAS IP54

128,50 USD



2000-1005 0-150mm " MAVİ SERİ " LCD DİJİTAL KUMPAS IP54

77,00 USD

2000-1010 0-200mm " MAVİ SERİ " LCD DİJİTAL KUMPAS IP54

95,00 USD

2000-1015 0-300mm " MAVİ SERİ " LCD DİJİTAL KUMPAS IP54

135,50 USD





2010-1005	0-150mm " MAVİ SERİ " LCD ABSOLUTE DİJİTAL KUMPAS IP54	96,50 USD
2010-1010	0-200mm " MAVİ SERİ " LCD ABSOLUTE DİJİTAL KUMPAS IP54	115,00 USD
2010-1015	0-300mm " MAVİ SERİ " LCD ABSOLUTE DİJİTAL KUMPAS IP54	160,00 USD



2406-1005	150mm KARBÜR AĞIZLI DİJİTAL KUMPAS	199,00 USD
2406-1010	200mm KARBÜR AĞIZLI DİJİTAL KUMPAS	241,50 USD
2406-1015	300mm KARBÜR AĞIZLI DİJİTAL KUMPAS	306,00 USD



2610-8105	0-150mm LCD BÜYÜK EKTRAN DİJİTAL KUMPAS IP67	120,00 USD
2610-8110	0-200mm LCD BÜYÜK EKTRAN DİJİTAL KUMPAS IP67	177,00 USD
2610-8115	0-300mm LCD BÜYÜK EKTRAN DİJİTAL KUMPAS IP67	220,50 USD



2015-1005	0-150mm "YENİ MAVİ SERİ" DİJİTAL KUMPAS IP67	135,50 USD
2015-1010	0-200mm "YENİ MAVİ SERİ" DİJİTAL KUMPAS IP67	194,00 USD
2015-1015	0-300mm "YENİ MAVİ SERİ" DİJİTAL KUMPAS IP67	239,50 USD

## Dasqua 150mm Stainless Steel IP67 Oil Proof Big Screen Digital Caliper



2L

2015-1005A

2015-1005A	0-150mm "YENİ MAVİ SERİ" DİJİTAL KUMPAS IP67 YAĞ KORUMALI	152,00 USD
2015-1010A	0-200mm "YENİ MAVİ SERİ" DİJİTAL KUMPAS IP67 YAĞ KORUMALI	228,00 USD
2015-1015A	0-300mm "YENİ MAVİ SERİ" DİJİTAL KUMPAS IP67 YAĞ KORUMALI	274,00 USD
2015-2405	150mm DİJİTAL KUMPAS IP67 YAĞ KORUMALI	147,00 USD
2015-2410	200mm DİJİTAL KUMPAS IP67 YAĞ KORUMALI	223,00 USD
2015-2415	300mm DİJİTAL KUMPAS IP67 YAĞ KORUMALI	269,00 USD

# Dasqua® NEW BUILT-IN BLUETOOTH IP54 ABSOLUTE DIGITAL CALIPER



- Strictly made in accordance with **DIN862**
- IP54 protection against water, oil, dust or any other liquid
- Silky smooth movement throughout
- Hardened, ground, and lapped measuring surface



Connect to any Bluetooth devices

Unit:mm

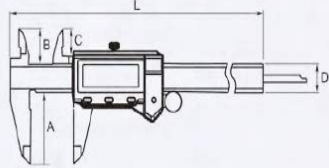

Item No.	Measuring range	Reading	A	B	C	D	L	Accuracy
2025-1005	0-150mm/0-6"	0.01mm/0.0005"/1/128"	40	20	15.5	16	235	0.02mm/0.001"
2025-1010	0-200mm/0-8"	0.01mm/0.0005"/1/128"	50	24	19.5	16	287	0.03mm/0.0015"
2025-1015	0-300mm/0-12"	0.01mm/0.0005"/1/128"	60	26	21.5	16	290	0.03mm/0.0015"

2025-1005 0-150mm DİJİTAL KUMPAS-BLUETOOTH ÖZELLİKLİ IP54

134,50 USD

## WITH WIRELESS SYSTEM



2020-1005 0-150mm DİJİTAL KUMPAS-Wİ-Fİ ÖZELLİKLİ IP67

178,00 USD



2220-8110	0-500mm TEK ÇENE DİJİTAL KUMPAS – IP54	428,00 USD
2220-8115	0-1000mm TEK ÇENE DİJİTAL KUMPAS – IP54	1077,00 USD
2220-3575	0-1500mm TEK ÇENE DİJİTAL KUMPAS – IP54	2075,00 USD
2220-3580	0-2000mm TEK ÇENE DİJİTAL KUMPAS – IP54	3078,00 USD



2320-1105	0-300mm TEK ÇENE DİJİTAL KUMPAS – BİLGİ ÇIKIŞLI IP65	330,00 USD
2320-1106	0-500mm TEK ÇENE DİJİTAL KUMPAS – BİLGİ ÇIKIŞLI IP65	525,00 USD
2320-1110	0-600mm TEK ÇENE DİJİTAL KUMPAS – BİLGİ ÇIKIŞLI IP65	570,00 USD
2320-1115	0-1000mm TEK ÇENE DİJİTAL KUMPAS – BİLGİ ÇIKIŞLI IP65	1170,00 USD

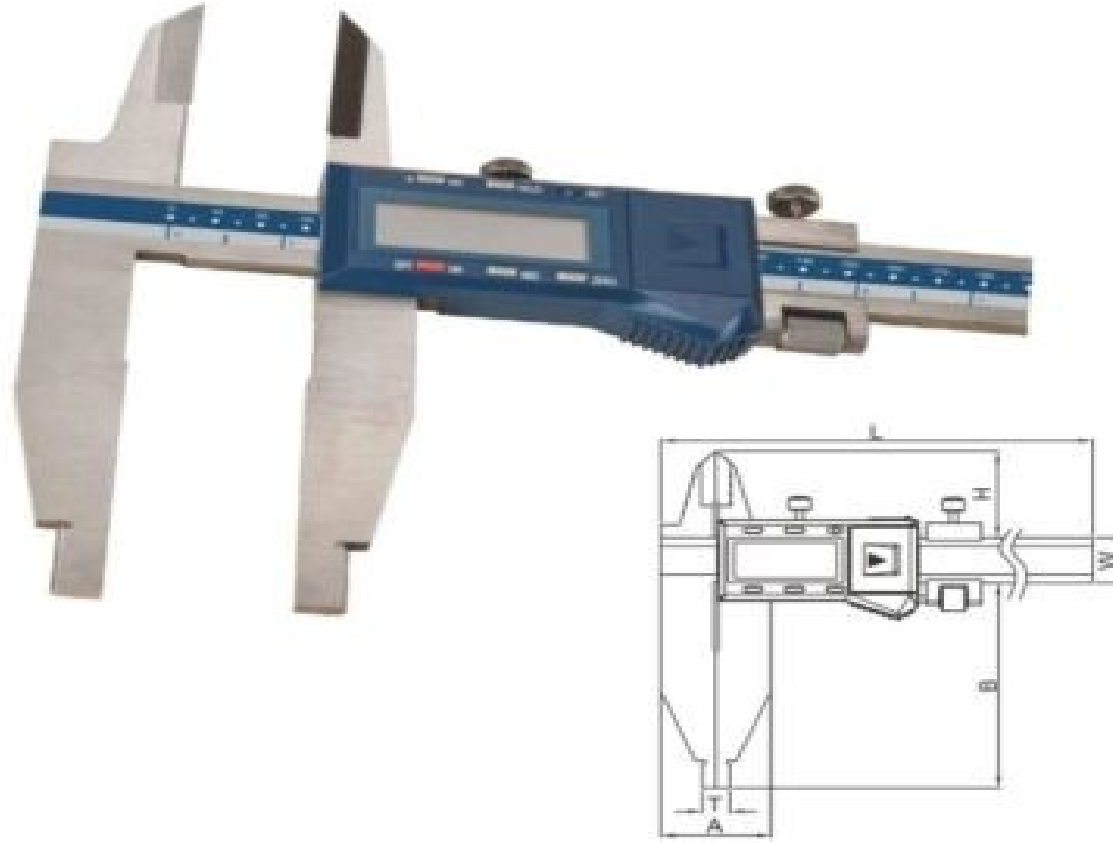

2710-1110 0-500mm ÇİFT ÇENE DİJİTAL KUMPAS – IP54 BİLGİ ÇIKISLI

538,50 USD

2710-1113 0-600mm ÇİFT ÇENE DİJİTAL KUMPAS –IP54 BİLGİ ÇIKISLI

723,00 USD

2710-1115 0-1000mm ÇİFT ÇENE DİJİTAL KUMPAS –IP54 BİLGİ ÇIKISLI

1222,00 USD

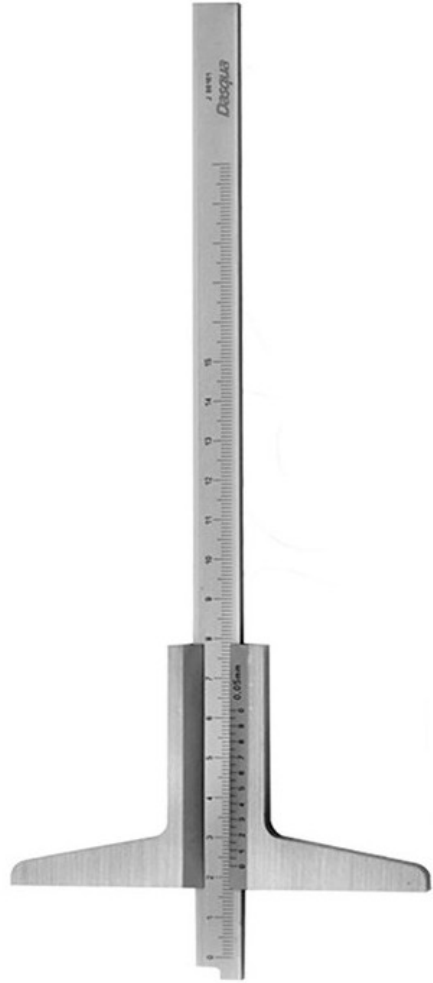

Type A



Type B

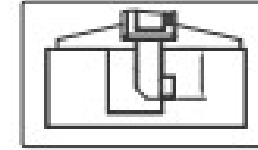
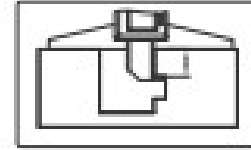
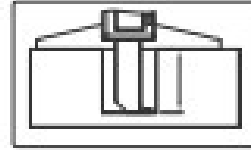
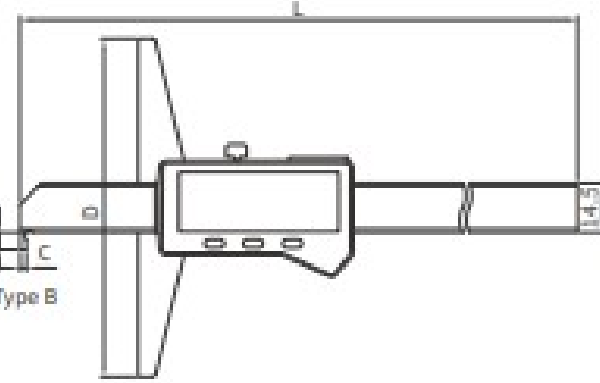

3001-1901	0-150mm MEKANİK DERİNLİK KUMPASI 0,02mm DIN862	51,00 USD
3001-1903	0-200mm MEKANİK DERİNLİK KUMPASI 0,02mm DIN862	56,00 USD
3001-1905	0-300mm MEKANİK DERİNLİK KUMPASI 0,02mm DIN862	94,50 USD
2001-1005	0-150mm DİJİTAL DERİNLİK KUMPASI 0,01 -TYPE B ÇENGELLİ	91,00 USD
2001-1010	0-200mm DİJİTAL DERİNLİK KUMPASI 0,01 -TYPE B ÇENGELLİ	114,50 USD
2001-1015	0-300mm DİJİTAL DERİNLİK KUMPASI 0,01 -TYPE B ÇENGELLİ	193,00 USD
2001-2005	0-150mm DİJİTAL DERİNLİK KUMPASI 0,01 -TYPE A	91,00 USD
2001-2010	0-200mm DİJİTAL DERİNLİK KUMPASI 0,01 -TYPE A	114,50 USD
2001-2015	0-300mm DİJİTAL DERİNLİK KUMPASI 0,01 -TYPE A	193,00 USD



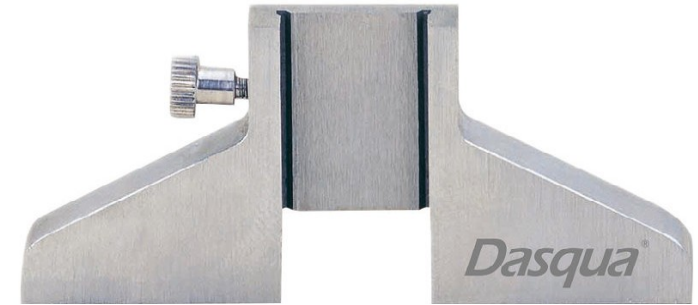

2330-1105	0-150mm DİJİTAL DERİNLİK KUMPASI IP67	135,00 USD
2330-1110	0-200mm DİJİTAL DERİNLİK KUMPASI IP67	170,00 USD
2330-1115	0-300mm DİJİTAL DERİNLİK KUMPASI IP67	235,00 USD
2460-1105	0-150mm DİJİTAL DERİNLİK KUMPASI - PİMLİ IP67	138,00 USD
2460-1110	0-200mm DİJİTAL DERİNLİK KUMPASI - PİMLİ IP67	174,00 USD
2460-1115	0-300mm DİJİTAL DERİNLİK KUMPASI - PİMLİ IP67	240,00 USD
3001-1001	DERİNLİK APARATI	20,00 USD

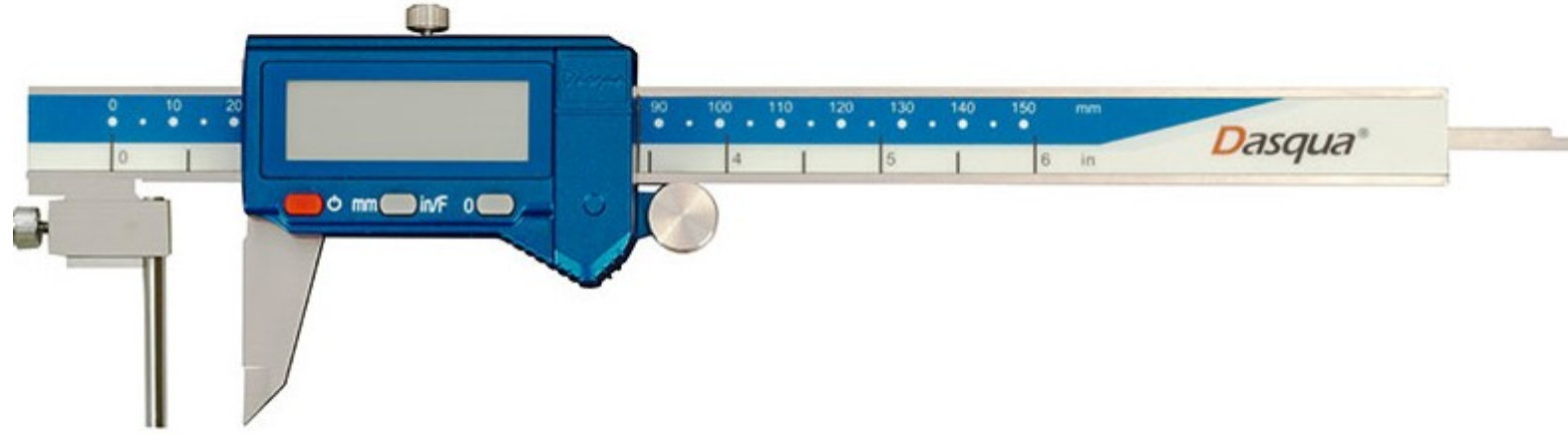

2060-1105	0-150mm/0-6" DİJİTAL BORU ET KALINLIĞI ÖLÇÜM KUMP 0,01	221,50 USD
2060-1110	0-200mm/0-8" DİJİTAL BORU ET KALINLIĞI ÖLÇÜM KUMP 0,01	236,00 USD
2060-1115	0-300mm/0-12" DİJİTAL BORU ET KALINLIĞI ÖLÇÜM KUMP 0,01	307,50 USD

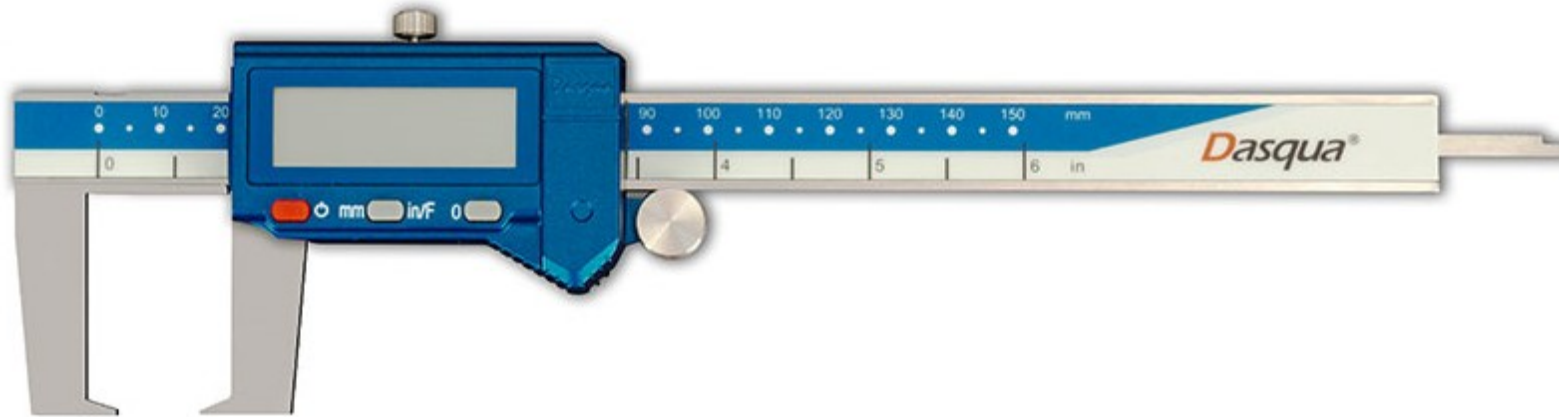

2065-1105	0-150mm DİJİTAL DIŞ ÇAP KANAL KUMPASI 0,01	154,00 USD
2065-1110	0-200mm DİJİTAL DIŞ ÇAP KANAL KUMPASI 0,01	204,50 USD
2065-1115	0-300mm DİJİTAL DIŞ ÇAP KANAL KUMPASI 0,01	244,00 USD

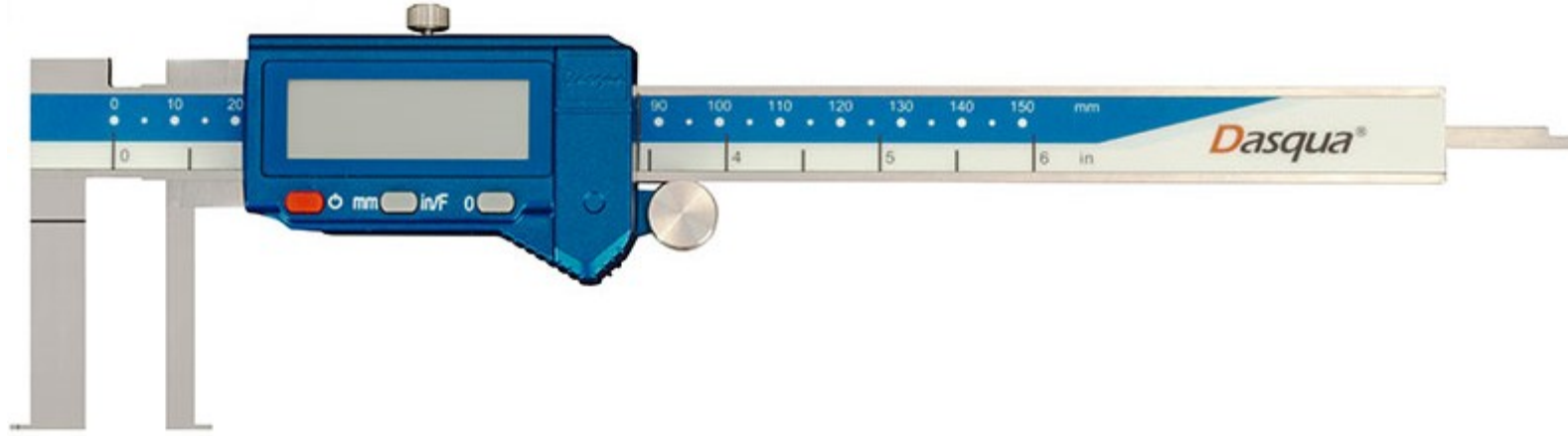

2070-1105	10-150mm DİJİTAL İÇ ÇAP KANAL KUMPASI IP54
2070-1110	11-200mm DİJİTAL İÇ ÇAP KANAL KUMPASI IP54
2070-1115	12-300mm DİJİTAL İÇ ÇAP KANAL KUMPASI IP54

152,00 USD
190,00 USD
240,00 USD

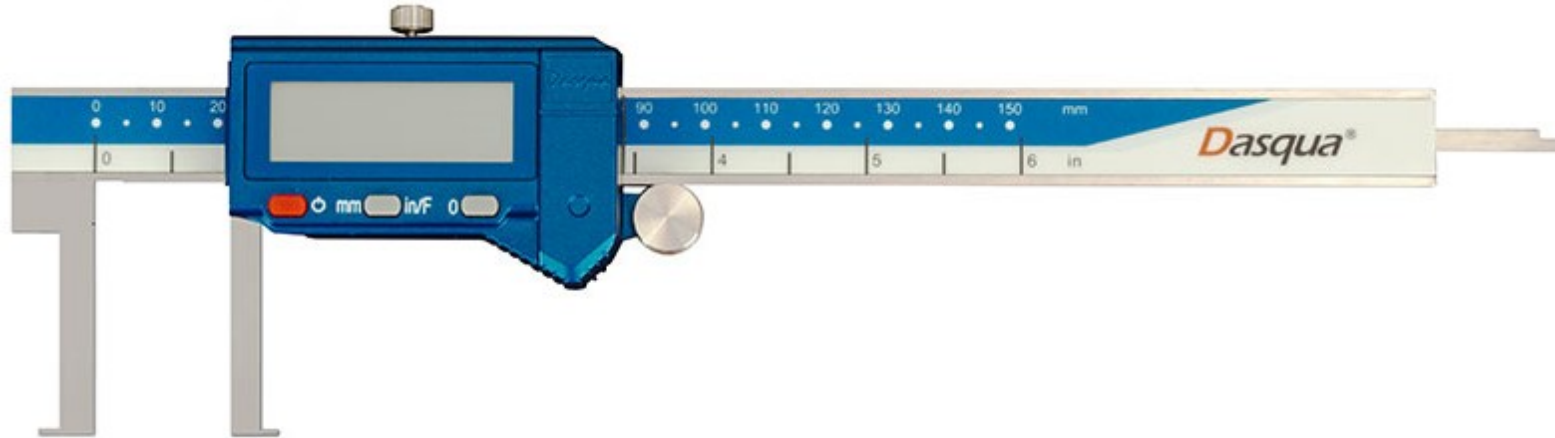

2080-1105	20-150mm DİJİTAL İÇ ÇAP KANAL KUMPASI IP54
2080-1110	25-200mm DİJİTAL İÇ ÇAP KANAL KUMPASI IP54
2080-1115	30-300mm DİJİTAL İÇ ÇAP KANAL KUMPASI IP54

164,00 USD
195,00 USD
246,00 USD



2240-0025	9-150mm DİJİTAL İÇ ÇAP KANAL KUMPASI	255,00 USD
2240-0026	10-200mm DİJİTAL İÇ ÇAP KANAL KUMPASI	300,00 USD
2240-0027	10-300mm DİJİTAL İÇ ÇAP KANAL KUMPASI	349,00 USD



2220-8103	100-500mm DİJİTAL İÇ ÇAP KANAL KUMPASI	243,00 USD
-----------	--	------------

1804-1030 0-80mm FREN DİSK KALINLIĞI ÖLÇÜM KUMPASI

158,00 USD



2240-0005 0-125mm DİJİTAL FREN DİSKİ KUMPASI

174,00 USD



2140-8101 HIZLI ÖLÇÜM KUMPASI

128,00 USD



8531-0005 MEKANİK KAYNAKÇI KUMPASI

37,00 USD

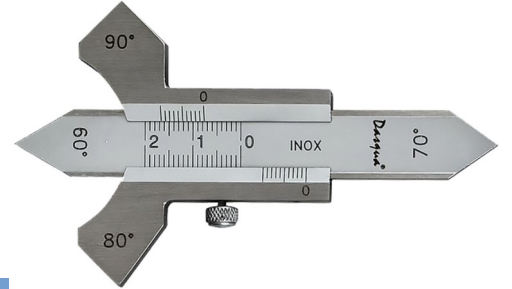

8530-1005 DİJİTAL KAYNAKÇI KUMPASI

110,00 USD



2140-8105 0-25mm DİJİTAL KALINLIK ÖLÇME 0,01/0,0005"

68,00 USD



4710-1205 0-25mm DİJİTAL DERİNLİK KUMPASI

79,50 USD



6111-1204 KUMPAS KONTROL MASTAR SETİ KALİTE-1

225,00 USD



**Dasqua**®



# MICROMETER

BORN IN ITALY, RAISED BY THE WORLD

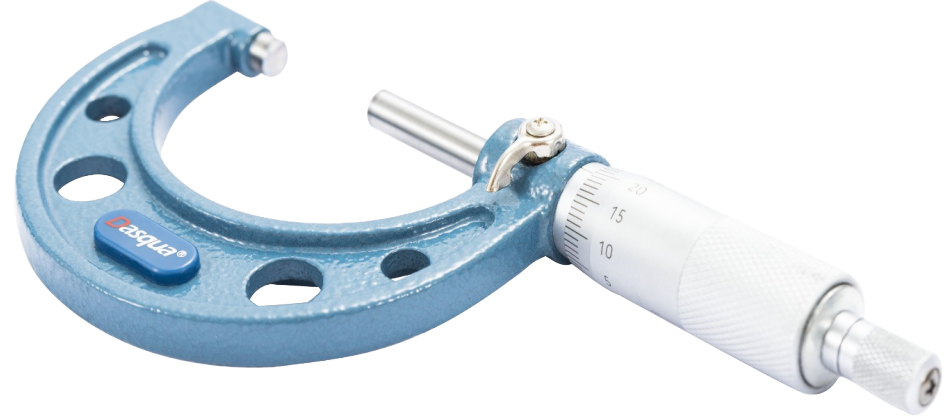

4111-8105A	0-25mm MEKANİK DIŞ ÇAP MİKROMETRE 0,01-Paslanmaz Mil	38,00 USD
4111-8110A	25-50mm MEKANİK DIŞ ÇAP MİKROMETRE 0,01-Paslanmaz Mil	45,50 USD
4111-8115A	50-75mm MEKANİK DIŞ ÇAP MİKROMETRE 0,01-Paslanmaz Mil	52,00 USD
4111-8120A	75-100mm MEKANİK DIŞ ÇAP MİKROMETRE 0,01-Paslanmaz Mil	60,50 USD
4111-8125A	100-125mm MEKANİK DIŞ ÇAP MİKROMETRE 0,01-Paslanmaz Mil	79,50 USD
4111-8130A	125-150mm MEKANİK DIŞ ÇAP MİKROMETRE 0,01-Paslanmaz Mil	92,00 USD
4112-8135	150-175mm MEKANİK DIŞ ÇAP MİKROMETRE 0,01	100,00 USD
4112-8140	175-200mm MEKANİK DIŞ ÇAP MİKROMETRE 0,01	113,50 USD
4112-8145	200-225mm MEKANİK DIŞ ÇAP MİKROMETRE 0,01	115,50 USD
4112-8150	225-250mm MEKANİK DIŞ ÇAP MİKROMETRE 0,01	119,00 USD
4112-8155	250-275mm MEKANİK DIŞ ÇAP MİKROMETRE 0,01	121,00 USD
4112-8160	275-300mm MEKANİK DIŞ ÇAP MİKROMETRE 0,01	128,00 USD





4111-5205	0-25mm MEKANİK DIŞ ÇAP MİKROMETRE 0,01-KROM KAPLAMA	38,00 USD
4111-5210	25-50mm MEKANİK DIŞ ÇAP MİKROMETRE 0,01-KROM KAPLAMA	45,50 USD
4111-5215	50-75mm MEKANİK DIŞ ÇAP MİKROMETRE 0,01-KROM KAPLAMA	52,00 USD
4111-5220	75-100mm MEKANİK DIŞ ÇAP MİKROMETRE 0,01-KROM KAPLAMA	60,50 USD



4111-8215A	0-150mm 6 PARÇA MEKANİK MİKROMETRE SETİ 0,01	337,00 USD
4111-8213	150-300mm 6 PARÇA MEKANİK MİKROMETRE SETİ 0,01	715,00 USD
4111-8203	0-300mm 12 PARÇA MEKANİK MİKROMETRE SETİ 0,01	919,00 USD
4111-8220	0-150mm 6 PARÇA MEKANİK MİKROMETRE SETİ 0,001	478,00 USD
4111-8408	0-300mm 12 PARÇA MEKANİK MİKROMETRE SETİ 0,001	1164,00 USD



4801-0007	300-400mm DEĞİŞTİRİLEBİLİR UÇLU MEKANİK DIŞ ÇAP MİKROMETRE 0,01	518,00 USD
4801-0008	400-500mm DEĞİŞTİRİLEBİLİR UÇLU MEKANİK DIŞ ÇAP MİKROMETRE 0,01	578,00 USD
4801-0009	500-600mm DEĞİŞTİRİLEBİLİR UÇLU MEKANİK DIŞ ÇAP MİKROMETRE 0,01	659,00 USD
4801-0010	600-700mm DEĞİŞTİRİLEBİLİR UÇLU MEKANİK DIŞ ÇAP MİKROMETRE 0,01	790,00 USD
4801-0011	700-800mm DEĞİŞTİRİLEBİLİR UÇLU MEKANİK DIŞ ÇAP MİKROMETRE 0,01	949,00 USD
4801-0012	800-900mm DEĞİŞTİRİLEBİLİR UÇLU MEKANİK DIŞ ÇAP MİKROMETRE 0,01	1102,00 USD
4801-0013	900-1000mm DEĞİŞTİRİLEBİLİR UÇLU MEKANİK DIŞ ÇAP MİKROMETRE 0,01	1261,00 USD
4800-0005	300-400mm AYARLANABİLİR UÇLU MEKANİK DIŞ ÇAP MİKROMETRE 0,01	465,00 USD
4800-0010	400-500mm AYARLANABİLİR UÇLU MEKANİK DIŞ ÇAP MİKROMETRE 0,01	502,00 USD
4800-0015	500-600mm AYARLANABİLİR UÇLU MEKANİK DIŞ ÇAP MİKROMETRE 0,01	587,00 USD
4800-0020	600-700mm AYARLANABİLİR UÇLU MEKANİK DIŞ ÇAP MİKROMETRE 0,01	708,00 USD
4800-0025	700-800mm AYARLANABİLİR UÇLU MEKANİK DIŞ ÇAP MİKROMETRE 0,01	843,00 USD
4800-0030	800-900mm AYARLANABİLİR UÇLU MEKANİK DIŞ ÇAP MİKROMETRE 0,01	906,00 USD
4800-0035	900-1000mm AYARLANABİLİR UÇLU MEKANİK DIŞ ÇAP MİKROMETRE 0,01	1039,00 USD

4111-8102A	0-25mm MEKANİK DİSK MİKROMETRE	138,00 USD
4111-8104A	25-50mm MEKANİK DİSK MİKROMETRE	148,00 USD
4111-8106A	50-75mm MEKANİK DİSK MİKROMETRE	180,00 USD
4111-8108A	75-100mm MEKANİK DİSK MİKROMETRE	199,00 USD



4811-8105	MİKROMETRE KAFASI MİNİ 0-6,5mm/0,01mm	30,00 USD
4811-8110	MİKROMETRE KAFASI 0-13mm/0,01mm	30,00 USD
4811-8115	MİKROMETRE KAFASI 0-25mm/0,01mm	33,00 USD
4811-8120	MİKROMETRE KAFASI 0-50mm/0,01mm	91,00 USD



4150-1005	0-25mm NUMARATÖRLÜ MİKROMETRE 0,01mm	103,00 USD
4150-1010	25-50mm NUMARATÖRLÜ MİKROMETRE 0,01mm	105,00 USD
4150-1015	50-75mm NUMARATÖRLÜ MİKROMETRE 0,01mm	115,50 USD



4610-1405	0-25mm SİVRİ UÇLU MİKROMETRE	79,50 USD
4610-1410	25-50mm SİVRİ UÇLU MİKROMETRE	93,00 USD
4570-1005	0-25mm BIÇAK AĞIZLI MEKANİK MİKROMETRE	170,00 USD
4570-1010	25-50mm BIÇAK AĞIZLI MEKANİK MİKROMETRE	218,00 USD

4611-8105	0-25mm MEKANİK DERİNLİK MİKROMETRESİ 0,01	77,50 USD
4611-8110	0-50mm MEKANİK DERİNLİK MİKROMETRESİ 0,01	80,50 USD
4611-8115	0-75mm MEKANİK DERİNLİK MİKROMETRESİ 0,01	85,00 USD
4611-8120	0-100mm MEKANİK DERİNLİK MİKROMETRESİ 0,01	91,00 USD



4911-8105	5-30mm MEKANİK İÇ ÇAP MİKROMETRE 0,01 – Karbür Ağızlı	104,00 USD
4911-8110	25-50mm MEKANİK İÇ ÇAP MİKROMETRE 0,01 – Karbür Ağızlı	115,50 USD
4911-8115	50-75mm MEKANİK İÇ ÇAP MİKROMETRE 0,01 – Karbür Ağızlı	123,00 USD
4911-8120	75-100mm MEKANİK İÇ ÇAP MİKROMETRE 0,01 – Karbür Ağızlı	135,50 USD
4911-8125	5-100mm MEKANİK İÇ ÇAP MİKROMETRE SETİ 0,01 – Karbür Ağızlı	397,50 USD
4311-8110	25-50mm MEKANİK İÇ ÇAP MİKROMETRE 0,01	108,00 USD
4311-8125	5-100mm MEKANİK İÇ ÇAP MİKROMETRE SETİ 0,01	324,00 USD



4411-9205	6-12mm MEKANİK 3 AYAKLI İÇ ÇAP MİKROMETRE SETİ 0,001	991,00 USD
4411-3210	12-20mm MEKANİK 3 AYAKLI İÇ ÇAP MİKROMETRE SETİ 0,005	514,00 USD
4411-3215	20-50mm MEKANİK 3 AYAKLI İÇ ÇAP MİKROMETRE SETİ 0,005	1738,50 USD
4411-3220	50-100mm MEKANİK 3 AYAKLI İÇ ÇAP MİKROMETRE SETİ 0,005	2265,00 USD

4311-8103	50-63mm BORU TİP İÇ ÇAP MİKROMETRESİ 0,01	180,00 USD
4311-8106	50-100mm BORU TİP İÇ ÇAP MİKROMETRESİ 0,01	191,00 USD
4311-8107	50-150mm BORU TİP İÇ ÇAP MİKROMETRESİ 0,01	196,00 USD
4311-8109	50-300mm BORU TİP İÇ ÇAP MİKROMETRESİ 0,01	245,00 USD
4311-8111	50-500mm BORU TİP İÇ ÇAP MİKROMETRESİ 0,01	294,00 USD



4631-0005	0-10mm SABİT KUVVET TEL MİKROMETRE	138,00 USD
-----------	------------------------------------	------------

6111-1211	MİKROMETRE KONTROL MASTAR SETİ ÇELİK ALAŞIM KALİTE-1	361,50 USD
-----------	--	------------





4210-2105	0-25mm DİJİTAL DIŞ ÇAP MİKROMETRE 0,001/0,00005"	84,00 USD
4210-2110	25-50mm DİJİTAL DIŞ ÇAP MİKROMETRE 0,001/0,00005"	104,00 USD
4210-2115	50-75mm DİJİTAL DIŞ ÇAP MİKROMETRE 0,001/0,00005"	125,00 USD
4210-2120	75-100mm DİJİTAL DIŞ ÇAP MİKROMETRE 0,001/0,00005"	146,00 USD
4210-2125	100-125mm DİJİTAL DIŞ ÇAP MİKROMETRE 0,001/0,00005"	180,00 USD
4210-2130	125-150mm DİJİTAL DIŞ ÇAP MİKROMETRE 0,001/0,00005"	220,50 USD
4210-2135	150-175mm DİJİTAL DIŞ ÇAP MİKROMETRE 0,001/0,00005"	347,00 USD
4210-2140	175-200mm DİJİTAL DIŞ ÇAP MİKROMETRE 0,001/0,00005"	380,50 USD
4210-2145	200-225mm DİJİTAL DIŞ ÇAP MİKROMETRE 0,001/0,00005"	422,00 USD
4210-2150	225-250mm DİJİTAL DIŞ ÇAP MİKROMETRE 0,001/0,00005"	460,00 USD
4210-2155	250-275mm DİJİTAL DIŞ ÇAP MİKROMETRE 0,001/0,00005"	496,00 USD
4210-2160	275-300mm DİJİTAL DIŞ ÇAP MİKROMETRE 0,001/0,00005"	538,50 USD



4410-1105	0-25mm DİJİTAL DIŞ ÇAP MİKROMETRE – BİLGİ ÇIKIŞLI IP65 0,001/0,00005"	136,00 USD
4410-1110	25-50mm DİJİTAL DIŞ ÇAP MİKROMETRE – BİLGİ ÇIKIŞLI IP65 0,001/0,00005"	165,00 USD
4410-1115	50-75mm DİJİTAL DIŞ ÇAP MİKROMETRE – BİLGİ ÇIKIŞLI IP65 0,001/0,00005"	180,00 USD
4410-1120	75-100mm DİJİTAL DIŞ ÇAP MİKROMETRE – BİLGİ ÇIKIŞLI IP65 0,001/0,00005"	196,00 USD
4410-1125	100-125mm DİJİTAL DIŞ ÇAP MİKROMETRE – BİLGİ ÇIKIŞLI IP65 0,001/0,00005"	226,00 USD
4410-1130	125-150mm DİJİTAL DIŞ ÇAP MİKROMETRE – BİLGİ ÇIKIŞLI IP65 0,001/0,00005"	264,00 USD

4220-2103	0-25mm DİJİTAL BIÇAK AĞIZLI HIZLI ÖLÇÜM MİKROMETRE	356,00 USD
4220-2106	25-50mm DİJİTAL BIÇAK AĞIZLI HIZLI ÖLÇÜM MİKROMETRE	394,00 USD



4220-2105	0-25mm HIZLI ÖLÇÜM DİJİTAL MİKROMETRE IP65 0,001/0,00005"	229,00 USD
4220-2110	25-50mm HIZLI ÖLÇÜM DİJİTAL MİKROMETRE IP65 0.001/0.00005"	267,00 USD
4220-2115	50-75mm HIZLI ÖLÇÜM DİJİTAL MİKROMETRE IP65 0,001/0,00005"	300,00 USD
4220-2120	75-100mm HIZLI ÖLÇÜM DİJİTAL MİKROMETRE IP65 0,001/0,00005"	334,00 USD





4230-2005	0-25mm DİJİTAL MİKROMETRE -PASLANMAZ MİL 0,001	95,00 USD
4230-2010	25-50mm DİJİTAL MİKROMETRE -PASLANMAZ MİL 0,001	115,00 USD
4230-2015	50-75mm DİJİTAL MİKROMETRE -PASLANMAZ MİL 0,001	137,00 USD
4230-2020	75-100mm DİJİTAL MİKROMETRE -PASLANMAZ MİL 0,001	158,00 USD
4230-2025	100-125mm DİJİTAL MİKROMETRE-PASLANMAZ MİL 0,001	192,00 USD
4230-2030	125-150mm DİJİTAL MİKROMETRE-PASLANMAZ MİL 0,001	230,00 USD

4710-2205 0-150mm DİJİTAL DERİNLİK MİKROMETRESİ 0,001/0,00005" 446,00 USD







4706-0004	300-400mm DEĞİŞTİREBİLİR UÇLU DİJİTAL DIŞ ÇAP MİKROMETRE 0,001	668,00 USD
4706-0005	400-500mm DEĞİŞTİREBİLİR UÇLU DİJİTAL DIŞ ÇAP MİKROMETRE 0,001	737,00 USD
4706-0006	500-600mm DEĞİŞTİREBİLİR UÇLU DİJİTAL DIŞ ÇAP MİKROMETRE 0,001	795,00 USD
4706-0007	600-700mm DEĞİŞTİREBİLİR UÇLU DİJİTAL DIŞ ÇAP MİKROMETRE 0,001	843,00 USD
4706-0008	700-800mm DEĞİŞTİREBİLİR UÇLU DİJİTAL DIŞ ÇAP MİKROMETRE 0,001	949,00 USD
4706-0009	800-900mm DEĞİŞTİREBİLİR UÇLU DİJİTAL DIŞ ÇAP MİKROMETRE 0,001	1007,00 USD
4706-0010	900-1000mm DEĞİŞTİREBİLİR UÇLU DİJİTAL DIŞ ÇAP MİKROMETRE 0,001	1110,00 USD

4570-3005	0-25mm DİJİTAL BIÇAK AĞIZLI MİKROMETRE 0,001	445,00 USD
4570-3010	25-50mm DİJİTAL BIÇAK AĞIZLI MİKROMETRE 0,001	495,00 USD



4470-0005	1-15mm DİJİTAL V-AĞIZLI MİKROMETRE IP65 3 AĞIZ	503,50 USD
4470-0010	5-20mm DİJİTAL V-AĞIZLI MİKROMETRE IP65 3 AĞIZ	519,50 USD

4910-2130	0-25mm DİJİTAL MİKROMETRE KAFASI -IP65 0,001	122,00 USD
4910-2135	0-50mm DİJİTAL MİKROMETRE KAFASI -IP65 0,001	231,00 USD

4520-1005	7-32mm DİJİTAL FREN DİSKİ MİKROMETRESİ 0,001	359,00 USD
4520-1010	18-43mm DİJİTAL FREN DİSKİ MİKROMETRESİ 0,001	400,00 USD

4910-4105	5-30mm DİJİTAL İÇ ÇAP MİKROMETRE 0,001/0,00005"	339,00 USD
4910-4110	25-50mm DİJİTAL İÇ ÇAP MİKROMETRE 0,001/0,00005"	353,00 USD
4910-4115	50-75mm DİJİTAL İÇ ÇAP MİKROMETRE 0,001/0,00005"	366,00 USD
4910-4120	75-100mm DİJİTAL İÇ ÇAP MİKROMETRE 0,001/0,00005"	403,00 USD



4511-9205	6-12mm DİJİTAL 3 AYAKLI İÇ ÇAP MİKROMETRE SETİ -IP54 0,001	1656,00 USD
4511-9210	12-20mm DİJİTAL 3 AYAKLI İÇ ÇAP MİKROMETRE SETİ -IP54 0,001	1143,00 USD
4511-9215	20-50mm DİJİTAL 3 AYAKLI İÇ ÇAP MİKROMETRE SETİ -IP54 0,001	2542,00 USD
4711-4405	6-12mm DİJİTAL 3 AYAKLI İÇ ÇAP MİKROMETRE SETİ -IP65 0,001	1772,00 USD
4711-4410	12-20mm DİJİTAL 3 AYAKLI İÇ ÇAP MİKROMETRE SETİ -IP65 0,001	1259,00 USD
4711-4415	20-50mm DİJİTAL 3 AYAKLI İÇ ÇAP MİKROMETRE SETİ -IP65 0,001	2682,00 USD
4711-4420	50-100mm DİJİTAL 3 AYAKLI İÇ ÇAP MİKROMETRE SETİ -IP65 0,001	3225,00 USD

4112-5105	0-1"MEKANİK DIŞ ÇAP MİKROMETRE 0,001"	39,00 USD
4112-5110	1-2"MEKANİK DIŞ ÇAP MİKROMETRE 0,001"	47,50 USD
4112-5115	2-3"MEKANİK DIŞ ÇAP MİKROMETRE 0,001"	54,00 USD
4112-5120	3-4"MEKANİK DIŞ ÇAP MİKROMETRE 0,001"	64,50 USD
4112-5125	4-5"MEKANİK DIŞ ÇAP MİKROMETRE 0,001"	73,00 USD
4112-5130	5-6"MEKANİK DIŞ ÇAP MİKROMETRE 0,001"	86,00 USD
4112-5135	6-7"MEKANİK DIŞ ÇAP MİKROMETRE 0,001"	99,50 USD
4112-5140	7-8"MEKANİK DIŞ ÇAP MİKROMETRE 0,001"	111,00 USD
4112-5145	8-9"MEKANİK DIŞ ÇAP MİKROMETRE 0,001"	119,00 USD
4112-5150	9-10"MEKANİK DIŞ ÇAP MİKROMETRE 0,001"	126,00 USD
4112-5155	10-11"MEKANİK DIŞ ÇAP MİKROMETRE 0,001"	138,00 USD
4112-5160	11-12"MEKANİK DIŞ ÇAP MİKROMETRE 0,001"	144,00 USD
4802-0007	12-16"DEĞİŞTİRİLEBİLİR UÇLU MEKANİK DIŞ ÇAP MİKROMETRE 0,0001"	827,00 USD
4810-0005	12-16"AYARLANABİLİR UÇLU MEKANİK DIŞ ÇAP MİKROMETRE 0,001"	482,00 USD
4810-0010	16-20"AYARLANABİLİR UÇLU MEKANİK DIŞ ÇAP MİKROMETRE 0,001"	519,50 USD
4810-0015	20-24"AYARLANABİLİR UÇLU MEKANİK DIŞ ÇAP MİKROMETRE 0,001"	606,00 USD
4810-0020	24-28"AYARLANABİLİR UÇLU MEKANİK DIŞ ÇAP MİKROMETRE 0,001"	740,00 USD
4810-0025	28-32"AYARLANABİLİR UÇLU MEKANİK DIŞ ÇAP MİKROMETRE 0,001"	965,00 USD
4810-0030	32-36"AYARLANABİLİR UÇLU MEKANİK DIŞ ÇAP MİKROMETRE 0,001"	1057,00 USD
4810-0035	36-40"AYARLANABİLİR UÇLU MEKANİK DIŞ ÇAP MİKROMETRE 0,001"	1180,00 USD
4112-0105	0-1"MEKANİK DIŞ ÇAP MİKROMETRE 0,0001"	46,50 USD
4112-0110	1-2"MEKANİK DIŞ ÇAP MİKROMETRE 0,0001"	54,00 USD
4112-0115	2-3"MEKANİK DIŞ ÇAP MİKROMETRE 0,0001"	64,50 USD
4112-0120	3-4"MEKANİK DIŞ ÇAP MİKROMETRE 0,0001"	72,00 USD
4112-0125	4-5"MEKANİK DIŞ ÇAP MİKROMETRE 0,0001"	80,50 USD
4112-0130	5-6"MEKANİK DIŞ ÇAP MİKROMETRE 0,0001"	94,50 USD
4112-0216	0-6" 6 PARÇA MEKANİK MİKROMETRE SETİ 0,001"	382,00 USD
4112-0218	6-12" 6 PARÇA MEKANİK MİKROMETRE SETİ 0,001"	747,00 USD
4112-0208	0-12" 12 PARÇA MEKANİK MİKROMETRE SETİ 0,001"	1132,00 USD
4112-0215	0-6" 6 PARÇA MEKANİK MİKROMETRE SETİ 0,0001"	588,00 USD
4112-0213	6-12" 6 PARÇA MEKANİK MİKROMETRE SETİ 0,0001"	894,50 USD
4112-0203	0-12" 12 PARÇA MEKANİK MİKROMETRE SETİ 0,0001"	1433,00 USD
4312-5103	2-2,5" BORU TİP İÇ ÇAP MİKROMETRESİ 0,001"	194,00 USD
4312-5106	2-4" BORU TİP İÇ ÇAP MİKROMETRESİ 0,001"	201,5,00 USD
4312-5109	2-12" BORU TİP İÇ ÇAP MİKROMETRESİ 0,001"	297,00 USD
4312-5112	2-20" BORU TİP İÇ ÇAP MİKROMETRESİ 0,001"	348,00 USD
4312-5113	2-40" BORU TİP İÇ ÇAP MİKROMETRESİ 0,001"	1035,00 USD
4612-5120	0-4" MEKANİK DERİNLİK MİKROMETRESİ 0,001"	114,00 USD



# INDICATOR

BORN IN ITALY, RAISED BY THE WORLD

5111-1005 0-10mm KOMPARATÖR SAATİ 0,01

35,00 USD



5111-1205 0-10mm KOMPARATÖR SAATİ 0,01

39,00 USD



5121-1202 0-5mm Mini KOMPARATÖR SAATİ 0,01

48,00 USD



5121-1205 0-10mm KOMPARATÖR SAATİ "SHOCKPROF" 0,01

50,00 USD



5121-2201 0-1mm KOMPARATÖR SAATİ 0,001

115,00 USD



5121-1210 0-30mm UZUN KOMPARATÖR SAATİ 0,01

75,00 USD

5121-1215 0-50mm UZUN KOMPARATÖR SAATİ 0,01

167,50 USD



5121-1107 0-10mm IP54 KOMPARATÖR SAATİ 0,01

77,00 USD

5121-2107 0-10mm IP67 KOMPARATÖR SAATİ 0,001

138,00 USD



5361-0005 IP53 KOMPARATÖR SAATİ 0,05

372,00 USD



5821-1100 0-10mm MEKANİK DERİNLİK KOMPARATÖR SETİ

190,00 USD



5111-1010 MANYETİK KOMPARATÖR KAPAĞI

30,00 USD



5330-8105 0-12,7mm DİJİTAL KOMPARATÖR SAATI – BİLGİ ÇIKIŞLI 0,01mm / 0,0005" 115,50 USD



5260-1105 0-12,7mm DİJİTAL KOMPARATÖR SAATI -BASİC MODEL 0,01/0,0005" 105,00 USD

5260-1110 0-25,4mm DİJİTAL KOMPARATÖR SAATI -BASİC MODEL 0,01/0,0005" 146,00 USD

5260-1115 0-50,8mm DİJİTAL KOMPARATÖR SAATI -BASİC MODEL 0,01/0,0005" 295,00 USD



5260-3710 0-25,4mm DİJİTAL KOMPARATÖR SAATI -TOLERANS GİRİŞLİ 0,01/0,0005" 172,00 USD

5260-3715 0-50,8mm DİJİTAL KOMPARATÖR SAATI -TOLERANS GİRİŞLİ 0,01/0,0005" 376,00 USD





5260-4205	0-12,7mm DİJİTAL KOMPARATÖR SAATI -TOLERANS GİRİŞLİ 0,001/0,0005"	225,00 USD
5260-4210	0-25,4mm DİJİTAL KOMPARATÖR SAATI -TOLERANS GİRİŞLİ 0,001/0,0005"	272,00 USD



5340-8105	0-12,7mm ABSOLUTE DİJİTAL KOMPARATÖR SAATI – BİLGİ ÇIKIŞLI 0,01	153,00 USD
5340-8110	0-25,4mm ABSOLUTE DİJİTAL KOMPARATÖR SAATI – BİLGİ ÇIKIŞLI 0,01	185,50 USD
5340-9105	0-12,7mm ABSOLUTE DİJİTAL KOMPARATÖR SAATI – BİLGİ ÇIKIŞLI 0,001	288,00 USD
5340-9110	0-25,4mm ABSOLUTE DİJİTAL KOMPARATÖR SAATI – BİLGİ ÇIKIŞLI 0,001	356,00 USD
5340-9115	0-50,8mm ABSOLUTE DİJİTAL KOMPARATÖR SAATI – BİLGİ ÇIKIŞLI 0,001	534,00 USD





**Dasqua**®

5221-1129 A	MEKANİK SALGI KOMPARATÖRÜ DARBE DAYANIKLI PROB-13,5mm SAAT ÇAPI 29 0,01mm	85,00 USD
5221-1140	MEKANİK SALGI KOMPARATÖRÜ DARBE DAYANIKLI PROB-13,5mm SAAT ÇAPI 40 0,01mm	104,00 USD
5221-3105	MEKANİK SALGI KOMPARATÖRÜ DARBE DAYANIKLI PROB-13,5mm SAAT ÇAPI 34,5 0,002mm	119,00 USD
5221-1115	MEKANİK SALGI KOMPARATÖRÜ ÇİFT YÖNLÜ HAREKET SAAT ÇAPI 37,5 0,01mm	113,50 USD



5221-1205	MEKANİK SALGI KOMPARATÖRÜ DARBE DAYANIKLI PROB-30mm SAAT ÇAPI 42 0,01mm	136,00 USD
5221-1210	MEKANİK SALGI KOMPARATÖRÜ DARBE DAYANIKLI PROB-37,5mm SAAT ÇAPI 42 0,01mm	136,00 USD
5221-1215	MEKANİK SALGI KOMPARATÖRÜ DARBE DAYANIKLI PROB-30mm SAAT ÇAPI 30,5 0,01mm	122,00 USD
5221-1220	MEKANİK SALGI KOMPARATÖRÜ DARBE DAYANIKLI PROB-37,5mm SAAT ÇAPI 30,5 0,01mm	122,00 USD

5221-1000	İKİ YÖNLÜ MEKANİK KOMPARATÖR SETİ 0-0,8mm 0,01	118,00 USD
-----------	--	------------

5410-8110	DİJİTAL SALGI KOMPARATÖRÜ 0-0,8mm 0,01	250,00 USD
5410-8205	DİJİTAL SALGI KOMPARATÖRÜ 0-0,8mm IP65 0,001	262,00 USD
5221-1070	PROB UCU -YAKUT	12,00 USD
5221-1072	PROB UCU 0,001 – İNCE DİŞ	11,00 USD

## FOR DIAL TEST INDICATOR



● 5221-1070  
Made of ruby



5221-1000



5511-1100	4-6mm SİLİNDİR KOMPARATÖRÜ L-40mm 0,01	376,00 USD
5511-1105	6-10mm SİLİNDİR KOMPARATÖRÜ L-40mm 0,01	173,00 USD
5511-1110	10-18mm SİLİNDİR KOMPARATÖRÜ L-100mm 0,01	163,00 USD
5511-1115	18-35mm SİLİNDİR KOMPARATÖRÜ L-150mm 0,01	161,00 USD
5511-1120	35-50mm SİLİNDİR KOMPARATÖRÜ L-150mm 0,01	164,00 USD
5511-1125	50-100mm SİLİNDİR KOMPARATÖRÜ L-150mm 0,01	167,50 USD
5511-1130	50-160mm SİLİNDİR KOMPARATÖRÜ L-150mm 0,01	170,00 USD
5511-1135	160-250mm SİLİNDİR KOMPARATÖRÜ L-400mm 0,01	228,00 USD
5511-1140	250-450mm SİLİNDİR KOMPARATÖRÜ L-400mm 0,01	333,00 USD
5581-0005	400-800mm SİLİNDİR KOMPARATÖRÜ L-400mm 0,01	398,00 USD
5510-0010	18-160mm SİLİNDİR KOMPARATÖR SETİ 0,01	406,00 USD
5510-0005	35-160mm SİLİNDİR KOMPARATÖR SETİ 0,01	254,50 USD
5512-6110	0,4-0,7" SİLİNDİR KOMPARATÖRÜ L-4" 0,0005"	168,50 USD
5512-6115	0,7-1,5" SİLİNDİR KOMPARATÖRÜ L-6" 0,0005"	177,00 USD
5512-6120	1,4-2,4" SİLİNDİR KOMPARATÖRÜ L-6" 0,0005"	180,00 USD
5512-6125	2-4" SİLİNDİR KOMPARATÖRÜ L-6" 0,0005"	178,00 USD
5512-6130	2-6" SİLİNDİR KOMPARATÖRÜ L-6" 0,0005"	182,00 USD
5512-6135	6-10" SİLİNDİR KOMPARATÖRÜ L-16" 0,0005"	243,00 USD
5512-6140	10-16" SİLİNDİR KOMPARATÖRÜ L-16" 0,0005"	336,00 USD
5510-0000	1,4-6" SİLİNDİR KOMPARATÖR SETİ 0,0005"	276,00 USD



5210-1105	6-10mm/0,24-0,4" ABSOLUTE DİJİTAL SİLİNDİR KOMPARATÖR SETİ 0,001/0,0005"	426,00 USD
5210-1110	10-18mm/0,4-0,7" ABSOLUTE DİJİTAL SİLİNDİR KOMPARATÖR SETİ 0,001/0,0005"	409,00 USD
5210-1115	18-35mm/0,7-1,5" ABSOLUTE DİJİTAL SİLİNDİR KOMPARATÖR SETİ 0,001/0,0005"	496,00 USD
5210-1120	30-50mm/1,4-2,4" ABSOLUTE DİJİTAL SİLİNDİR KOMPARATÖR SETİ 0,001/0,0005"	496,00 USD

5921-0005 3-13mm DELİK MASTAR SETİ 30,00 USD



5911-0002 Ø8-150mm TELESKOPIK MASTAR SETİ L-150mm 55,00 USD  
5911-0001 Ø8-150mm TELESKOPIK MASTAR SETİ L-300mm 83,00 USD

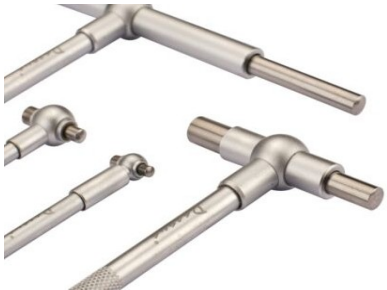

5721-0005	0-20mm	DIŞ ÇAP KOMPARATÖRÜ	0,01	200,00 USD
5721-0010	20-40mm	DIŞ ÇAP KOMPARATÖRÜ	0,01	210,00 USD
5721-0015	40-60mm	DIŞ ÇAP KOMPARATÖRÜ	0,01	215,00 USD
5721-0020	60-80mm	DIŞ ÇAP KOMPARATÖRÜ	0,01	220,00 USD
5721-0025	80-100mm	DIŞ ÇAP KOMPARATÖRÜ	0,01	230,00 USD



5810-2005	15-35mm	İÇ ÇAP KOMPARATÖRÜ	0,01	200,00 USD
5810-2010	35-55mm	İÇ ÇAP KOMPARATÖRÜ	0,01	210,00 USD
5810-2015	55-75mm	İÇ ÇAP KOMPARATÖRÜ	0,01	220,00 USD
5810-2020	75-95mm	İÇ ÇAP KOMPARATÖRÜ	0,01	230,00 USD
5810-2025	95-115mm	İÇ ÇAP KOMPARATÖRÜ	0,01	242,00 USD
5810-2030	115-135mm	İÇ ÇAP KOMPARATÖRÜ	0,01	255,00 USD



5630-1005	0-20mm	DİJİTAL DIŞ ÇAP KOMPARATÖRÜ	0,01/0,0005"	345,00 USD
5630-1010	20-40mm	DİJİTAL DIŞ ÇAP KOMPARATÖRÜ	0,01/0,0005"	352,00 USD
5630-1020	60-80mm	DİJİTAL DIŞ ÇAP KOMPARATÖRÜ	0,01/0,0005"	365,00 USD
5630-1025	80-100mm	DİJİTAL DIŞ ÇAP KOMPARATÖRÜ	0,01/0,0005"	385,00 USD



5811-0005	15-35mm	DİJİTAL İÇ ÇAP KOMPARATÖRÜ	0,01/0,0005"	355,00 USD
5811-0010	35-55mm	DİJİTAL İÇ ÇAP KOMPARATÖRÜ	0,01/0,0005"	375,00 USD
5811-0015	55-75mm	DİJİTAL İÇ ÇAP KOMPARATÖRÜ	0,01/0,0005"	380,00 USD
5811-0020	75-95mm	DİJİTAL İÇ ÇAP KOMPARATÖRÜ	0,01/0,0005"	395,00 USD
5811-0025	95-115mm	DİJİTAL İÇ ÇAP KOMPARATÖRÜ	0,01/0,0005"	420,00 USD
5811-0030	115-135mm	DİJİTAL İÇ ÇAP KOMPARATÖRÜ	0,01/0,0005"	430,00 USD



5800-1015 55-153mm DEĐİŐTİRİLEBİLİR UÇLU İÇ ÇAP KOMPARATÖRÜ 328,00 USD



1804-1010 12,7-165mm DİJİTAL İÇ ÇAP KANAL KOMPARATÖRÜ 165,00 USD



5841-8110 0-10mm MEKANİK KALINLIK KOMPARATÖRÜ 40,00 USD



2140-8110 0-25mm DİJİTAL KALINLIK KOMPARATÖRÜ 0,01mm 56,00 USD



5840-6200 0-10 DİJİTAL KALINLIK KOMPARATÖRÜ -SERAMİK 145,00 USD



5840-6205 0-10 DİJİTAL KALINLIK KOMPARATÖRÜ -DERİN BOĞAZ 165,00 USD





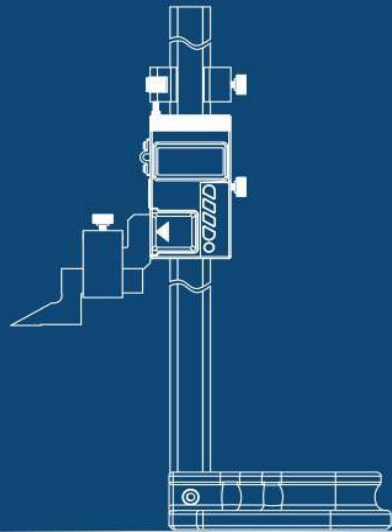

# HEIGHT GAUGE

BORN IN ITALY, RAISED BY THE WORLD



3110-6105	0-300mm MEKANİK CAM MERCEKLİ MİHENGİR	269,00 USD
3110-6120	0-600mm MEKANİK CAM MERCEKLİ MİHENGİR	429,00 USD
3110-6125	0-1000mm MEKANİK CAM MERCEKLİ MİHENGİR	1409,00 USD

3130-4703	0-300mm ABSOLUTE DİJİTAL MİHENGİR - BİLGİ ÇIKIŞLI IP65	545,00 USD
3130-4716	0-600mm ABSOLUTE DİJİTAL MİHENGİR - BİLGİ ÇIKIŞLI IP65	898,00 USD
3130-8116	0-600mm ABSOLUTE DİJİTAL MİHENGİR - BİLGİ ÇIKIŞLI	735,00 USD



3230-8105	0-300mm ÇİFT KOLON DİJİTAL MİHENGİR	514,00 USD
3230-8115	0-600mm ÇİFT KOLON DİJİTAL MİHENGİR	838,00 USD

7122-0005 80KG MEKANİK STANDART İNCE AYARLI MANYETİK AYAK

31,00 USD

7700-0005 80KG MEKANİK STANDART MANYETİK AYAK

30,00 USD



7122-0025



7700-0005



7122-0005

7122-0025 30KG İNCE AYARLAMALI MANYETİK AYAK

71,00 USD

7111-1000 MANYETİK TABANLI MİKROMETRE STANDI (300mm KADAR)

71,00 USD

7111-1105 MİKROMETRE STANDI (100mm KADAR)

26,50 USD



7312-0005 30KG UNİVERSAL MANYETİK STAND-MİNİ

68,00 USD

7312-0010 80KG UNİVERSAL MANYETİK STAND

79,50 USD



7412-0005 80KG HİDROLİK MANYETİK STAND

147,00 USD

7121-0020 50KG "MAVİ SERİ" GÜÇLENDİRİLMİŞ MANYETİK STAND

102,00 USD

7121-0025 80KG "MAVİ SERİ" GÜÇLENDİRİLMİŞ MANYETİK STAND

111,00 USD

7121-0030 100KG "MAVİ SERİ" GÜÇLENDİRİLMİŞ MANYETİK STAND BOY:355

136,00 USD

7121-0035 100KG "MAVİ SERİ" GÜÇLENDİRİLMİŞ MANYETİK STAND BOY:415

146,00 USD



7611-1005

ESNEK KROM MANYETİK AYAK SETİ

112,50 USD



7511-0005

10KG MİNİ MANYETİK STAND

49,00 USD



7521-0010

20KG MİNİ V TABANLI MANYETİK STAND

103,00 USD

7000-0005

80KG YEDEK MANYETİK TABAN M5x8,0

20,00 USD

7000-0010

100KG YEDEK MANYETİK TABAN M8x1,25

27,50 USD

7000-0015

130KG YEDEK MANYETİK TABAN M8x1,25

43,50 USD

7000-0020

30KG YEDEK MANYETİK TABAN M8x1,25

19,00 USD



7712-0005	DÖKÜM KOMPARATÖR STANDI Ø50	324,00 USD
7712-0010	DÖKÜM KOMPARATÖR STANDI 80x80mm	373,00 USD
7712-0015	DÖKÜM KOMPARATÖR STANDI 115x97mm	545,00 USD



● 7712-0005



7812-0005	GRANİT KOMPARATÖR STANDI 150x100mm	276,00 USD
7812-0010	GRANİT KOMPARATÖR STANDI 260x140mm	318,00 USD

7912-0004	GRANİT KOMPARATÖR STANDI 150x100x40mm	260,00 USD
7912-0005	GRANİT KOMPARATÖR STANDI 210x150x50mm	375,00 USD
7912-0010	GRANİT KOMPARATÖR STANDI 300x200mm Ø8	509,00 USD
7912-0015	GRANİT KOMPARATÖR STANDI 260x140mm Ø8	485,50 USD





# PRECISION LEVEL

BORN IN ITALY, RAISED BY THE WORLD

1022-1005 ENDÜSTRİYEL DİJİTAL AÇIÖLÇER 120x150mm 0,05 79,50 USD  
1022-1010 ENDÜSTRİYEL DİJİTAL AÇIÖLÇER 150x200mm 0,05 82,50 USD

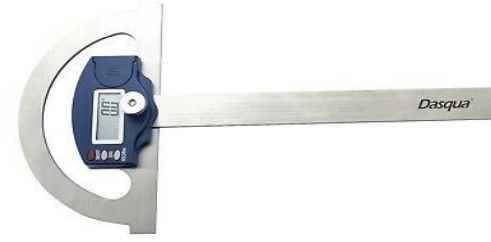

1021-2005 UNİVERSAL DİJİTAL AÇIÖLÇER 545,00 USD



1031-2005 UNİVERSAL MERCEKLİ AÇIÖLÇER 156,00 USD



1031-2010 UNİVERSAL SAATLİ AÇIÖLÇER 167,00 USD





1801-2005 SÜRGÜLÜ DİJİTAL İLETKİ 0-360'

39,00 USD



1022-0200 200mm DİJİTAL İLETKİ

50,00 USD

1022-0300 300mm DİJİTAL İLETKİ

59,00 USD

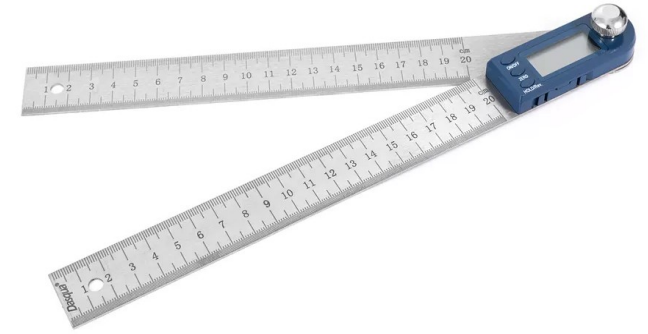

8400-0000 DİJİTAL AÇI ve EĞİM ÖLÇER

76,00 USD



8400-0010 DİJİTAL EĞİM ve AÇI ÖLÇER 4x90'

69,00 USD



8400-0020 4X90' DİJİTAL EĞİM ÖLÇER

47,00 USD



8400-0005 ABSOLUTE DİJİTAL AÇI ve EĞİM ÖLÇER IP65

115,50 USD

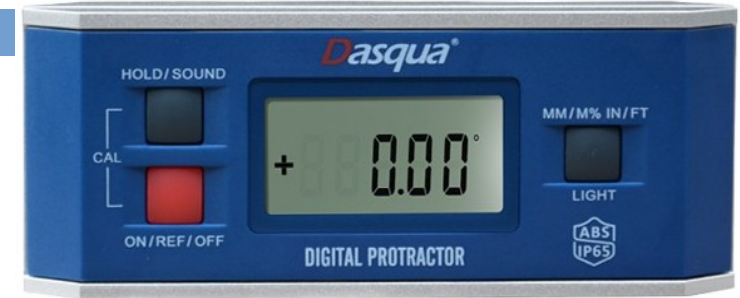

5712-1100 0-3mm MEKANİK MERKEZLEME PROBU 0,01mm

243,00 USD



7611-0020 MİNİ LED IŞIK MANYETİK TABANLI

43,50 USD

9111-1115 100x70mm 90' KIL GÖNYE 54,00 USD

9111-1120 150x100mm 90' KIL GÖNYE 97,50 USD

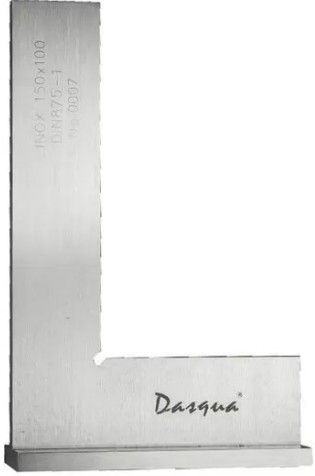

9212-1115 100X70mm 90' ŞAPKALI GÖNYE 72,00 USD

9212-1120 150x100mm 90' ŞAPKALI GÖNYE 111,00 USD

1012-2010 KOMBİNE AÇI ÖLÇER GÖNYE SETİ 160,00 USD



1030-2001 KIZILÖTESİ TERMOMETRE ( -20'/+320'C ) 73,00 USD



1801-0105 A PREMIUM MANYETİK PARALEL SET 2,5x100mm

157,00 USD



8201-0005 10 PARÇA EKSTRA İNCE HASSAS PARALEL SET 0,8x150mm

79,50 USD

8203-0010 14 PARÇA "PREMIUM" TAŞLANMIŞ PARALEL SET 10x150mm

238,50 USD

8203-0025 14 PARÇA "PREMIUM" TAŞLANMIŞ PARALEL SET 4x150mm

180,00 USD



## Anti-Collision

Edges are slightly lapped



8301-1005A	150mm HASSAS SU TERAZİSİ 0,02	189,00 USD
8301-1010A	200mm HASSAS SU TERAZİSİ 0,02	198,00 USD
8301-1015A	250mm HASSAS SU TERAZİSİ 0,02	215,00 USD



8301-1010B	200mm AHŞAP GÖVDE HASSAS SU TERAZİSİ 0,02	210,00 USD
8301-1015B	250mm AHŞAP GÖVDE HASSAS SU TERAZİSİ 0,02	230,00 USD

8301-2645	400mm DİJİTAL SU TERAZİSİ 0,1	57,00 USD
-----------	-------------------------------	-----------



**Dasqua**®

1122-9001 MEKANİK "Z" SIFIRLAMA SAATİ 50mm 0,01

148,50 USD



1801-1015 MEKANİK "Z" SIFIRLAMA SAATİ 50mm 0,01

295,00 USD

1801-1005 DİJİTAL "Z" SIFIRLAMA SAATİ 50mm 0,001 IP65

184,50 USD



5760-1005 IŞIKLI PROB

89,00 USD

5761-0010 MEKANİK SIFIRLAMA PROBU Ø4

14,00 USD



1804-1090 HA MEKANİK SHOREMETRE A

228,00 USD

#### Özellikler

Tip: Shore A

Ölçüm aralığı: 0-100HA

İğne basıncı aralığı: 2.5mm

Basıncı başlığı çapı: 0.79mm

Boyutlar: 115\*60\*25mm



1804-4612 PORTATİF SERTLİK ÖLÇME CİHAZI

820,00 USD

#### Özellikler

Darbe tipi: D,DC,DL,D+15,C,G

Doğruluk: ±6HL

Ölçekler: HRA, HRC, HRB, HB, HV, HSD, MPA

Ekran: 160\*128 TFT LCD

Veri: 500 adet

Güç: 3\*AAA pil

Bağlantı: Tip-C USB

Yazdırma: Kablosuz yazdırma(opsyonel)

Vurucu uç: Tungsten karbür top

Ağırlık: 230g

Boyutlar: 154\*82\*26mm

Çalışma sıcaklığı: -10 ~ +40°C (14~104)

Depolama sıcaklığı: -30 ~ +80°C (-22~176)



**Özellikler**

Maksimum ağırlık yükü: 150 kg (1471N)

Yük aralığı: 60,100,150,kg(588.4N,980.7N,1471N)

İlk aralık yükü: 10 kg (98.07N)

Maksimum test yüksekliği: 108m/m(4-1/4")

Boğaz derinliği: 135m/m(5-1/4")

Tablanın altında maksimum iş mili derinliği: 50m/m(2")

Tabanın boyutu: 180x465m/m(7"-18")

Makine yüksekliği: 630m/m(24-1/2")

Ağırlık (yaklaşık): 65 kg (150lbs)

**Standart aksesuarlar**

1 x Büyük test tablası  $\phi$ 150m/m(5-3/4")

1 x Küçük test tablası  $\phi$ 62m/m(2-3/8")

1 x V-blok tabla  $\phi$ 58(2-3/16")

1 x Elmas uç 120°

1 x Çelik bilyalı uç 1/16"

5 x Yedek çelik bilya 1/16"

1 x Rockwell A standart test bloğu

1 x Rockwell B standart test bloğu

1 x Rockwell C standart test bloğu

1 x Rockwell C standart test bloğu

1 x Rockwell C standart test bloğu

2 x Tornavida

3 x Seviye ayar ayağı

1 x Aksesuar kutusu

1 x Toz geçirmez plastik kapak

1 x Kullanım kılavuzu





**1804-6305 DİJİTAL YÜZEY PÜRÜZLÜLÜK CİHAZI****2100,00 USD****Özellikler**

Test parametreleri: Ra,Rz,Rq,Rt,Rp,Rv,R3z,R3y,RzJIS,  
Rsk,Rku,Rsm,Rmr,Rx;

Ölçüm aralığı (um): Ra: 0.005-16.000 / Rz: 0.02-160.00

Numune uzunluğu (mm): 0.25, 0.80, 2.50

Değerlendirme uzunluğu(mm): (1-5)L

Maksimum sürücü stroku: 17.5mm/0.7inch

Gösterge doğruluğu: 0.001

Gösterge hatası:  $\pm(7-10)\%$

Değişkenlik: <6%

Veri depolama: 100 ölçüm kaydı

Güç: Şarj edilebilir li-pil

Çalışma sıcaklığı: -20°C40°C

Size: 158mmx63.5mmx46mm

Weight of Host: 0.3kg

**Dahili Aksesuarlar**

Ana ünite	1 ad
Standart prob	1 ad
Kalibrasyon bloğu	1 ad
Kalibrasyon tablası	1 ad
Prob koruması	1 ad
USB kablo	1 ad
AC/DC adaptör	1 ad

**1804-6308 YÜZEY PÜRÜZLÜLÜK CİHAZ STANDI****562,00 USD**

8101-0005	30x36x40x45mm V BLOK SETİ	117,00 USD
8101-0010	32x40x45x70mm V BLOK SETİ	138,00 USD



8561-2005	MANYETİK TABANLI V BLOK 100x70x95	185,50 USD
8561-2010	MANYETİK TABANLI V BLOK 115x75x100	201,50 USD
8561-2015	MANYETİK TABANLI V BLOK 70x60x72	130,00 USD



8561-2030	MANYETİK V BLOK 70x40x50	220,00 USD
8561-2035	MANYETİK V BLOK 150x50x100	393,00 USD

6111-1232 32 PARÇA KALİBRASYON SETİ KALİTE-1  
6111-1247 47 PARÇA KALİBRASYON SETİ KALİTE-1  
6111-1287 87 PARÇA KALİBRASYON SETİ KALİTE-1

324,00 USD

514,00 USD

735,00 USD

## Industrial Quality

Precision ground, mirror polish, heat treatment and cryogenic treatment  
for all measuring surfaces.



FİLLER ÇAKISI 17 PARÇA 100mm / 0,02-1,00

FİLLER ÇAKISI 28 PARÇA 100mm / 0,05-1,00



Ø=7,0mm 17±17 RADUS MASTARI

14,00 USD



1 DİS TARAGI / METRİK-24 Prc / WHITWORTH-28 Prc



***Teknikal***

**HIRDAVAT ve ÖLÇÜ ALETLERİ**